



**Hydraulic
Power
Unit
2-Stage
Braking**



WHERE TO USE

The 2-stage hydraulic power unit provide a 2-stage controlled braking sequence for use with hydraulic fail-safe spring applied disc brakes. The 2-stage braking sequence is used to prevent a hard braking sequence, which in worst case can cause too high stress on the mechanical parts, or unwanted wear of the system through uncontrolled braking.

BRAKING PERFORMANCE

During opening of the brakes the pressure is build up and thereby opening the brake(s). The first stage of the braking sequence is dumping the pressure to the correct pressure and after the 2-stage braking time the pressure is smoothly reduced and thereby increasing the braking torque.

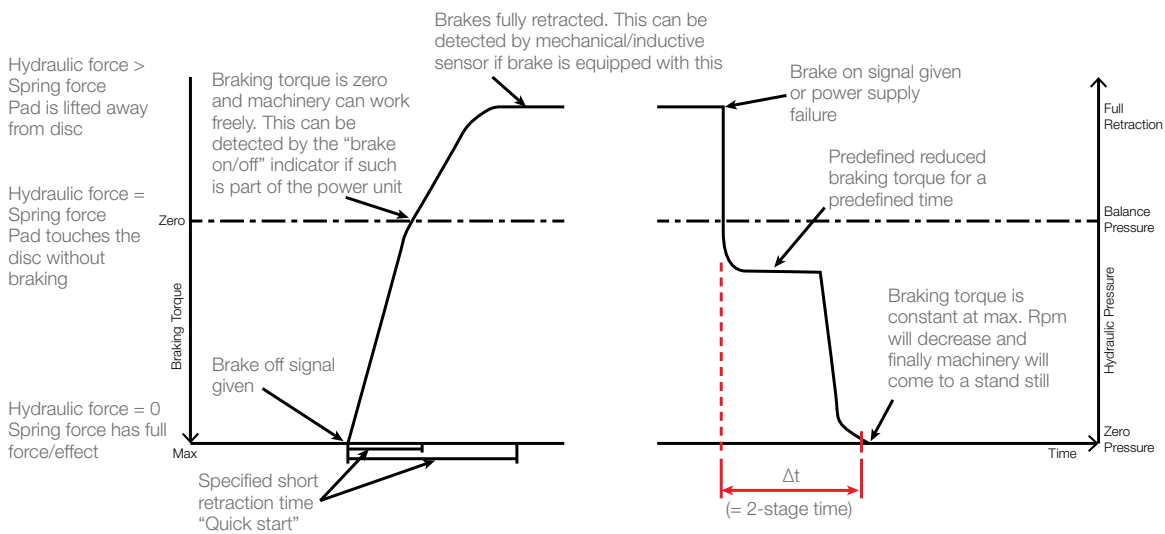

FUNCTIONAL DESCRIPTION

Operation (Not Braking)

Electrical power is connected to the electrical motor and the solenoid valve(s) is/are energized. The braking valve(s) is/are closed and block the connection to tank. The hydraulic pressure is built up and disengages the brake and charges the accumulator.

The electrical power is disconnected from the motor by means of the motor pressure switch. The braking valve(s) is/are constantly energized. If the pressure is decreasing to the lower set point for motor pressure switch the motor will restart and increase the pressure again.

Applying the Brake with Controlled Braking Torque

The electrical power is disconnected to the braking valve(s) and motor. The hydraulic oil pressure is released to the tank through the counter pressure valve(s) and the throttle valve(s), resulting in a constant reduced braking torque (MT%).

The reduced braking time is set by the flow control valve by bleeding the oil from the accumulator slowly through the flow control valve, maintaining a constant pressure in the brakes. When the accumulator is fully discharged the pressure in the brake will go to zero, and full braking torque is applied.

The constant brake torque and braking time is pre-set from factory as specified or if not specified set to 50% (MT%) of maximum torque and approximately 10sec stopping time (Δt).

Operation in Case of Power Failure

In case of power failure the brakes will be applied as described in the section: Applying the brake with controlled braking torque.



FEATURES

The hydraulic power unit is available in two versions; a basic (single dump) and a premium (dual dump) with cabinet / enclosure with various options and accessories.

The junction box / terminal box is mounted internally in the upper left hand side. Cable entry is in left hand side with removable entry plate in brass. The cabinet door is hinged either left hand or right hand side. The pressure connection / bulkhead (JIC as standard / Ermeto fitting 10L as optional) is mounted in left hand side but can be mounted in the right hand side or in the bottom as well.

2-Stage Braking Special Features

- Single return line / dump (Basic) or Dual return lines / dump for redundancy (Premium)
- Counter pressure valve(s) and throttle valve(s)
- Equipped with hand pump for manual release of brake
- Inline high pressure filter
- LED's on solenoids
- Test point for readout / bleeding of manifold
- Pressure switch either electronic or mechanical type
- Level & temperature switch in tank
- Pressure gauge mounted on test point (minimess) hose inside cabinet
- Stainless steel enclosure mounted on bracket with vibration dampers
- Enclosure door with cam lock with double bit as standard or upgraded with stainless pad-lockable swing handle (optional)
- Removable drip tray to capture spills
- HPU can be mounted on slides for easy maintenance (optional)
- Sun roof / dirt cover 30° (optional)



HYDRAULIC DIAGRAM

The schematics illustrates the difference between basic (single return) & premium (double return). The additional circuit on the premium version is marked with red in the below image.

The motor pressure switch can either be mechanical type (2 switches) or electronic type (IFM) (1 switch) – here shown as electronic type.

Basic Version: Single Dump / Single Return Line

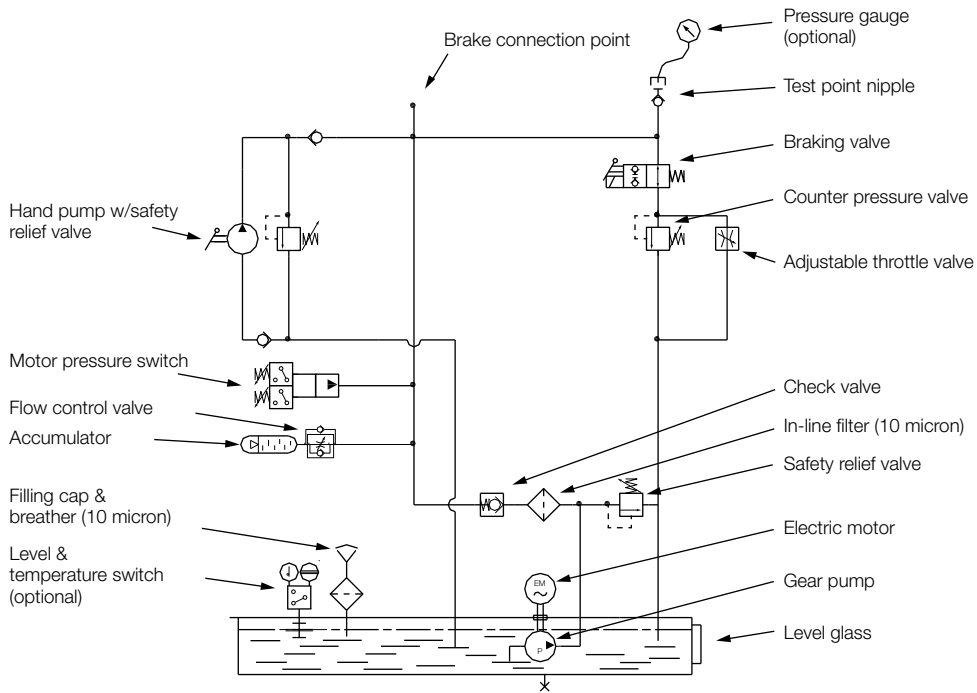

Premium Version: Double Dump / Dual Return Line

Red area indicates additional circuit for redundant return/dump

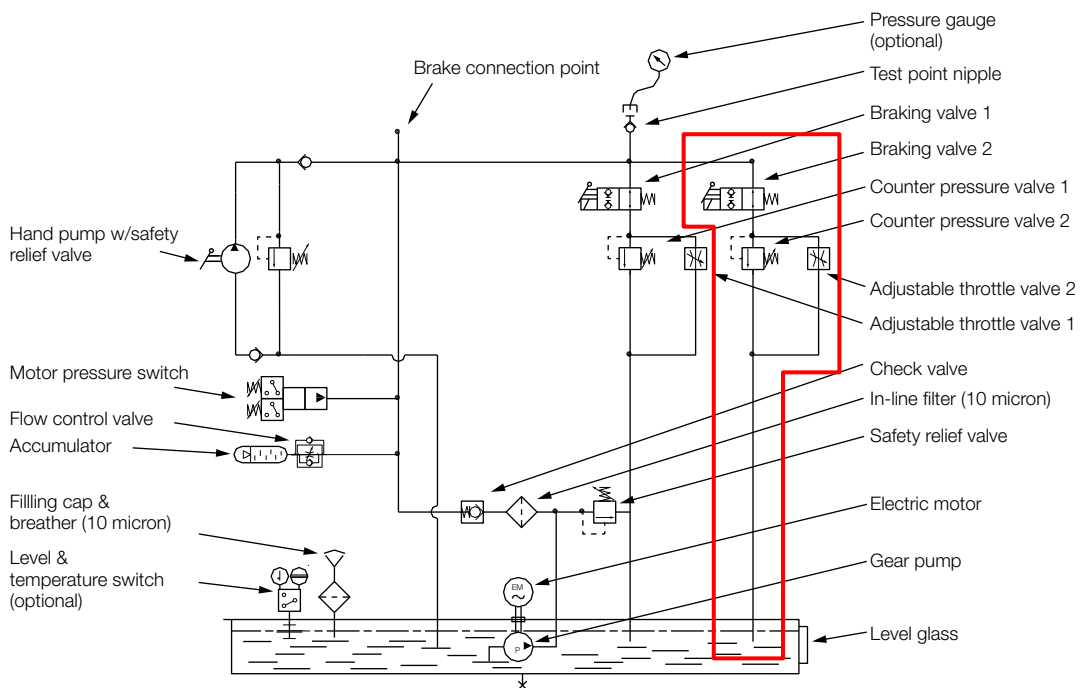

ELECTRICAL DIAGRAM / SCHEMATIC

The electrical components on the hydraulic power unit – excluding the motor - are prewired to the junction box.

The motor supply wire and motor starter is not part of the unit and must be provided locally.

The connection from installation to junction box and motor is to be made through the removable brass entry plate in the left hand side and must be made during installation. It is not normal to connect the brake indicators through the junction box on the unit.

The electrical diagram / schematic vary according to the selections made (basic / premium / mechanical or electronic pressure switch) – below two typical schematics

Premium Version (Redundant Valves) with IFM Pressure Switch:

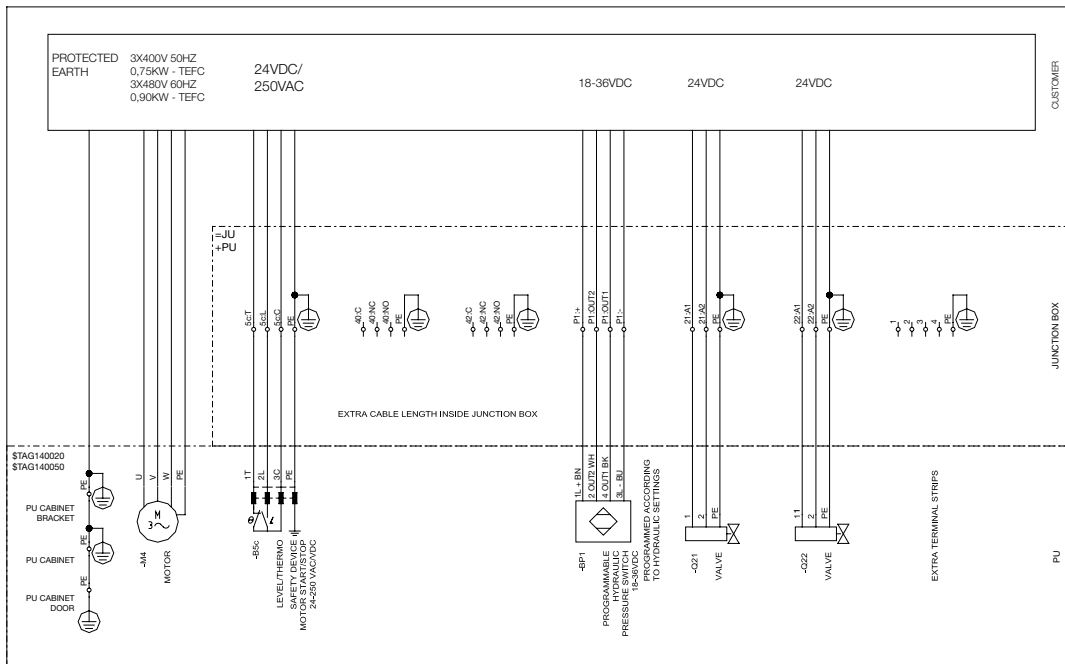

Premium Version (Redundant Valves) with Mechanical Pressure Switch:

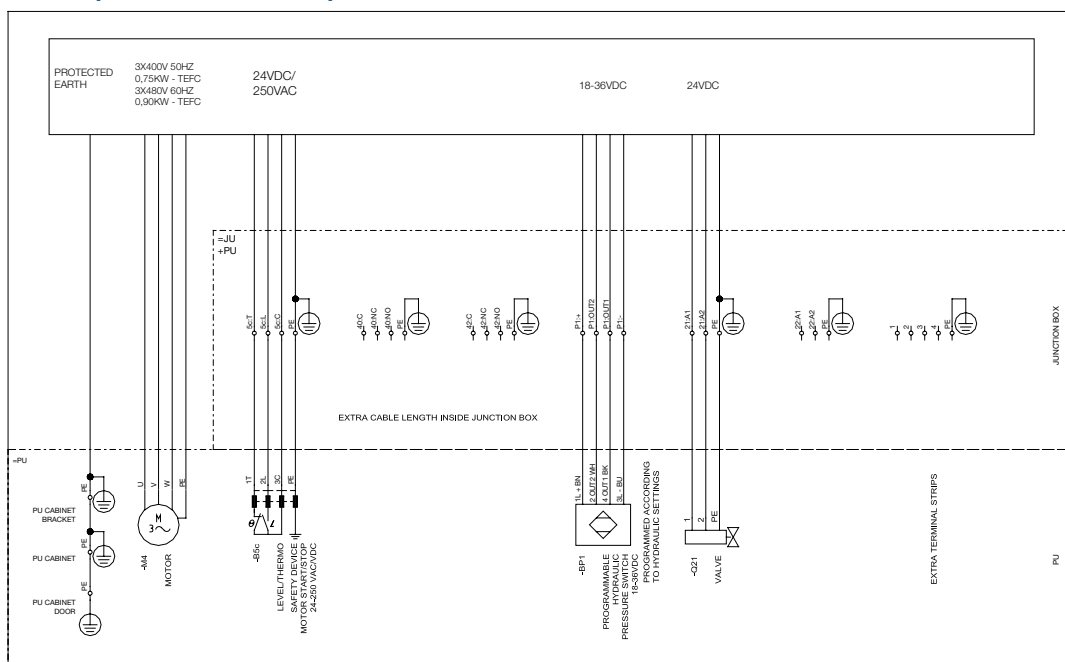

Component List (Quantities depend on configuration)

| | | |
|----------------------------|--|--|
| Valves / Coil | Directional poppet valve 2/2 & coil 21W (1x or 2x) - Hydac | |
| Pressure switch | Electronic sensor (1x) – IFM 7001 Mechanical pressure switch (2x) - Bosch Rexroth HED5 | |
| Level & temperature switch | Level indicator with temperature switch 70°C - Lund & Sorensen | |
| Motor | IEC common motor 0,75kW for 50Hz / 0,90kW for 60Hz | |
| Terminals (in JB) | Screw terminals - Wago | |
| Wire colors | IEC Power circuit wiring colors Protective earth (PE) Green-yellow Neutral (N) Blue Line, single phase (L) Brown Line, 3 phase (L1) Brown Line, 3 phase (L2) Black Line, 3 phase (L3) Grey | |

Recommended Brake Limits for 2 Stage Pressures

Choosing brake torques and brake sizes that result in a hydraulic two stage pressure lower than 10bar (lower limit) is not recommended as the counter pressure valve is very difficult to set at this low pressure.

The brake pressure curves indicate the two stage pressure at the corresponding torque. If pressure is below the 'lower limit' the combination is not recommended.

BSFI 200 Series:

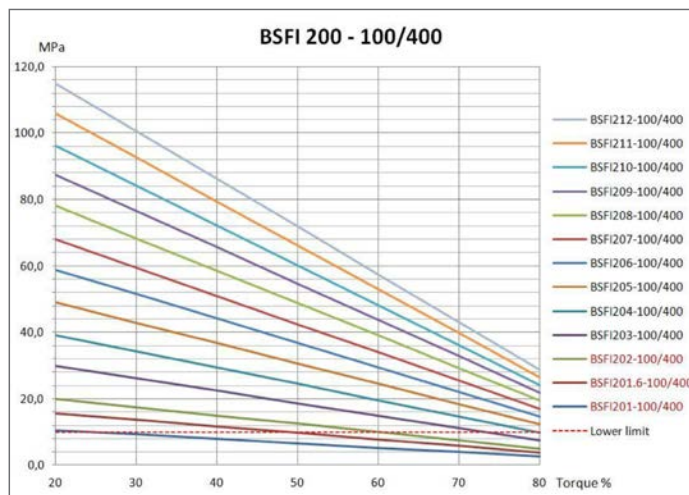

BSFI 300 Series:

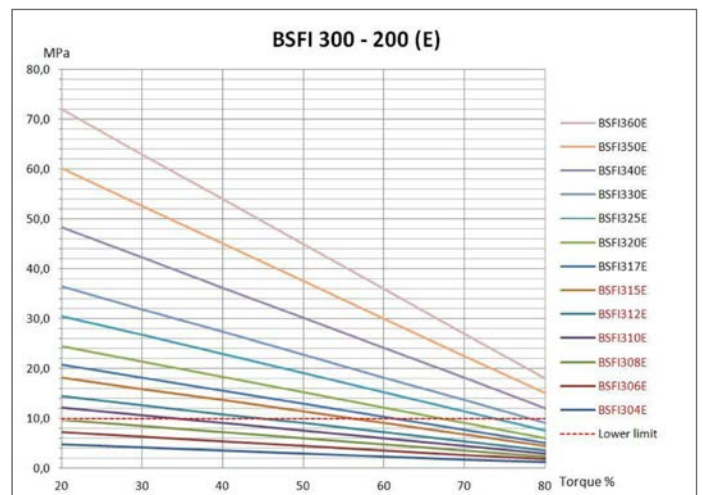

BSFI 3000 Series:

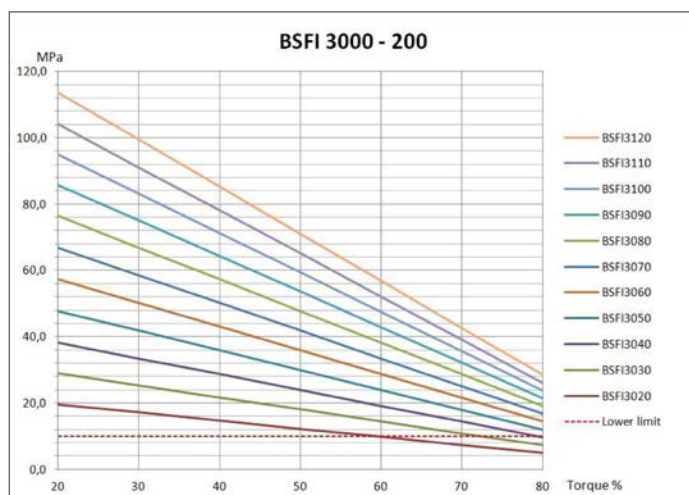

SELECTION SHEET – 2 STAGE HYDRAULIC POWER UNIT

Dimensions (600x800x400mm) (WxHxD)

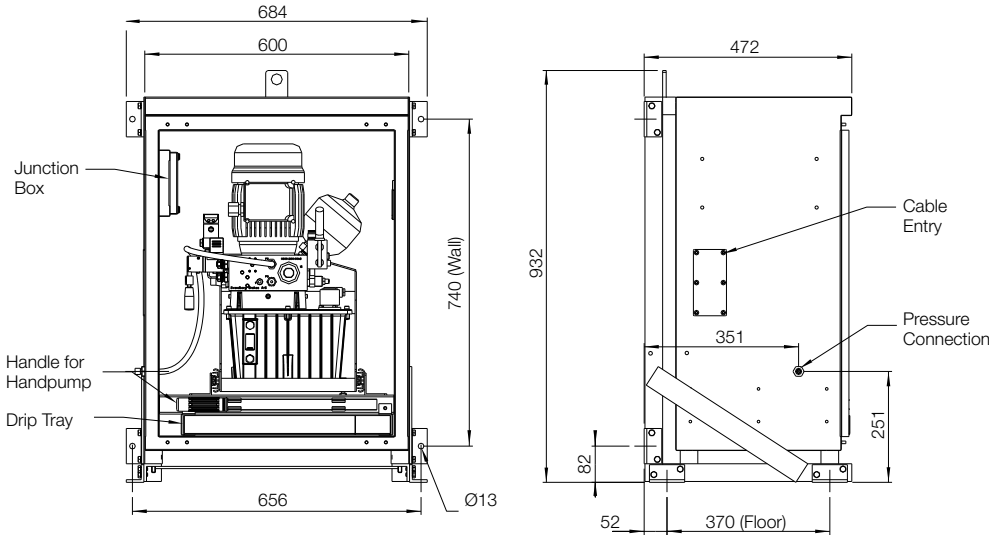

Technical Specifications

Motor standard

IEC – TEFC (fan cooled)
IEC – TENV (non ventilated)

Available motor voltages

AC 50Hz / 60 Hz
1 x 230V
3 x 400V / 480V
3 x 500V / 575V
3 x 690V / 690V

All AC motors have voltage tolerance $\pm 10\%$
Power consumption:
0.75kW (50Hz)
0.90KW (60Hz)

Available Coil Voltages

DC: 12V, 24V, 48V, 110V
AC: 110V, 230V

Power consumption: 19W (one coil)

Oil Tank Size

6 liter / 1.58 gallon (US) /
1.32 gallon (imperial)

Hand Pump

Inclusive

Pressure Switch

Electronic or Mechanical

Cabinet / Enclosure

Stainless steel (1.4305 /
AISI 304) incl. junction box

Protection class IP66

Protection class for electrical
components IP55

Internal wiring according to
IEC EN 60204-1

Mounted on suspension bracket with
dampers and lifting point.
Drip tray to take spills.
Slides for easy maintenance (optional).

Ambient Temperature Limits

-20°C to +50°C /
-4°F to +122°F

The hydraulic fluid must match
temperature level

Altitude

Below 1000 MASL

Weight

Approx.: 100kg / 220lb
(without oil)

HPU Selection Sheet

| | | | |
|---|-------------------------------------|---|--|
| Version (select one) Premium (dual return) Basic (single return) | | Accessories (select one) Unit mounted on slides (default) Unit fixed on bracket | |
| Motor (AC 50 Hz/60Hz) TEFC =Fan cooled TENC = Non Ventilated | (Select one) TENV TEFC | Door mounting (select one) Left side mounted (default) Right side mounted | |
| 1x230V 50 Hz / 1x230V 60 Hz | – | Cabinet accesories Cam lock with double bit (default) Pad-Lockable swing handle | |
| 3x400V 50 Hz / 3x480V 60 Hz | – | Coil voltage (select one) AC DC | |
| 3x500V 50 Hz / 3x575V 60 Hz | – | 12 VDC – | |
| 3x690V 50 Hz / 6x690V 60 Hz | – | 24 VDC – | |
| | | 48 VAC / VDC | |
| | | 110 VAC | |
| | | 230 VAC | |
| Pressure switch (select one) Electrical (IFM) (Port P1) Mechanical (Port 40 & 42) | | Pressure connection entry (select one) Left side mounted (default) Right side mounted Bottom (left) mounted | |
| Hydraulic / brake parameters: Brake series / size: _____ Type of brake (Mono / Dual) _____ Number of brakes: _____ pcs Braking torque $M_T\%$ (30-70%):(% of 100% torque) _____ % Braking time Δt (5-25sec): (2-stage time) _____ Sec Standard (if no values given): $M_T\% = 50\%$ & $\Delta t = 10$ sec | | Pressure connection type (select one) JIC connection (default) Ermeto connection (10L) | |
| Customer Name / Project: Other Information: Name & Date: | | | |

Svendborg Brakes Facilities

Europe

Jernbanevej 9
DK-5882 Vejstrup - Denmark
+45 63 255 255
sb@svendborg-brakes.com
*Industrial Brakes and
Brake Systems*

Global Representations

Australia
Svendborg Brakes Australia Pty., Ltd.
Perth
+61 (0) 8 94 160300

Svendborg Brakes Australia Pty., Ltd.
Newcastle
+61 (0) 8 94 160300

Svendborg Brakes Australia Pty., Ltd.
Brisbane
+61 (0) 8 94 160300

Brazil
Altra Industrial Motion Brazil
+55 11 4615-6300 /
+55 11 5679-6553

Chile
Svendborg Brakes Chile
Coquimbo
+56 23 203 9150

Svendborg Brakes Chile
Santiago
+56 23 203 9150

China
Svendborg Brakes Shanghai Co., Ltd.
+86 21 50311060

Czech Republic
Svendborg Brakes Czech Republic
+420 (251) 6801 68

Denmark
Svendborg Brakes ApS
+45 63 255 255

Germany
Svendborg Brakes ApS
+49 5422 9272 00

India
Svendborg Brakes India
sb@svendborg-brakes.com

Korea
Svendborg Brakes, Korea Co., Ltd.
+82 10 9703 0979

Poland
Svendborg Brakes Poland
+48 (322) 1150 40

South Africa
Altra Industrial Motion South Africa
+27 (0) 11 918-4270

Spain
Svendborg Brakes
+34 (975) 2336 55

USA
Svendborg Brakes, USA LLC
+1 (303) 285 1271

The Brands of Altra Industrial Motion

Couplings

Ameridrives
www.ameridrives.com

Bibby Turboflex
www.bibbyturboflex.com

Guardian Couplings
www.guardiancouplings.com

Huco
www.huco.com

Lamiflex Couplings
www.lamiflexcouplings.com

Stromag
www.stromag.com

TB Wood's
www.tbwoods.com

Geared Cam Limit Switches

Stromag
www.stromag.com

Electric Clutches & Brakes

Inertia Dynamics
www.idicb.com

Matrix
www.matrix-international.com

Stromag
www.stromag.com

Warner Electric
www.warnerelectric.com

Linear Products

Warner Linear
www.warnerlinear.com

Engineered Bearing Assemblies

Kilian
www.kilianbearings.com

Heavy Duty Clutches & Brakes

Industrial Clutch
www.indclutch.com

Twiflex
www.twiflex.com

Stromag
www.stromag.com

Svendborg Brakes
www.svendborg-brakes.com

Wichita Clutch
www.wichitacutch.com

Belted Drives

TB Wood's
www.tbwoods.com

Gearing

Bauer Gear Motor
www.bauergears.com

Boston Gear
www.bostongear.com

Delroyd Worm Gear
www.delroyd.com

Nuttall Gear
www.nuttallgear.com

Overrunning Clutches

Formsprag Clutch
www.formsprag.com

Marland Clutch
www.marland.com

Stieber Clutch
www.stieberclutch.com

Neither the accuracy nor completeness of the information contained in this publication is guaranteed by the company and may be subject to change in its sole discretion. The operating and performance characteristics of these products may vary depending on the application, installation, operating conditions and environmental factors. The company's terms and conditions of sale can be viewed at <http://www.altramotion.com/terms-and-conditions/sales-terms-and-conditions>. These terms and conditions apply to any person who may buy, acquire or use a product referred to herein, including any person who buys from a licensed distributor of these branded products.

©2017 by Svendborg Brakes LLC. All rights reserved. All trademarks in this publication are the sole and exclusive property of Svendborg Brakes LLC or one of its affiliated companies.